



# 10/100/1000Base SMD Transformer

PartNumber: SG24301 G

- Compliant with IEEE 802.3 standard,
- RoHS compliant.
- Operating temperature range : 0°C to +70°C.
- Storage temperature range: 0°C to +85°C

### Electrical Specifications @ 25°C

Part Number	Turns Ratio (±5%)		DCR (OHM Max)				Leakage Inductance LL (uH Max)	Insertion Loss (dB Max) 1-100MHz	HI-POT (Vrms)				
	TX	RX	1-2	5-6	7-8	11-12				13-14	17-18	19-20	23-24
SG24301 G	1CT:1CT	1CT:1CT	0.8				1.0				0.35	-1.0	1500

### Continue

Part Number	Return Loss (dB Min)					Cross Talk(dB Min)			DCMR (dB Min)		
	1-30MHz	40MHz	50MHz	60-80MHz	100MHz	30MHz	60MHz	100MHz	30MHz	60MHz	100MHz
SG24301 G	-18	-16	-16	-12	-10	-45	-40	-35	-43	-37	-33

### Schematics:

### Mechanicals:

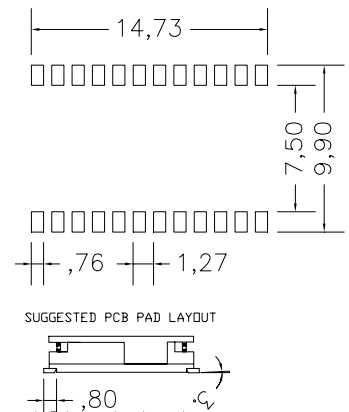
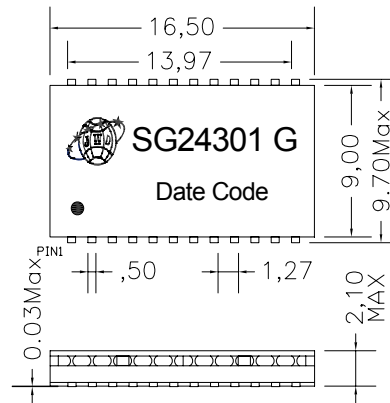
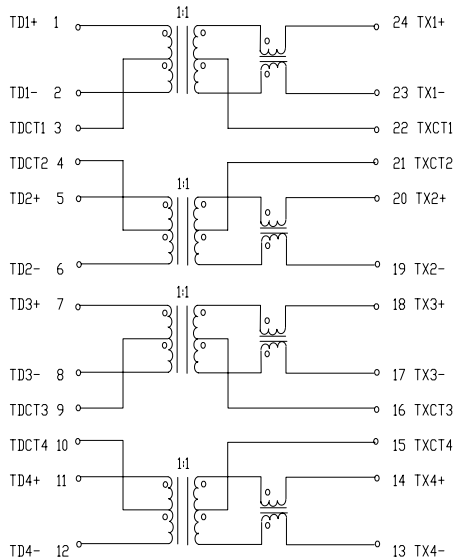

Unless otherwise specified, tolerances  
 xx.x0±0.25(mm)    0.xx±0.05(mm)



# 10/100/1000Base SMD Transformer

PartNumber: SG24301 G

Page:2/2

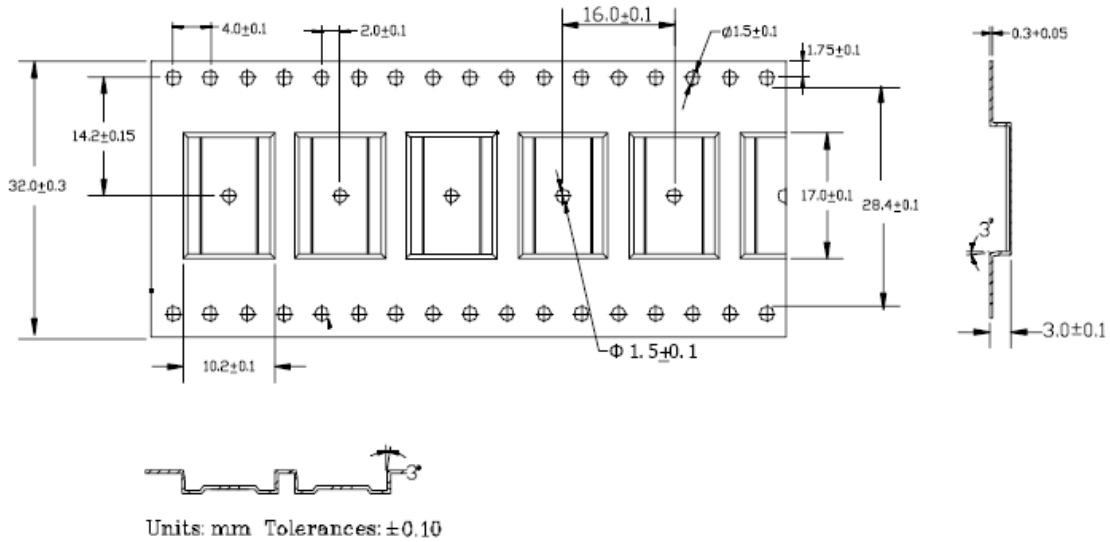

## REEL MECHANICAL DIMENSION

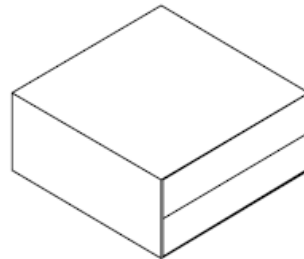
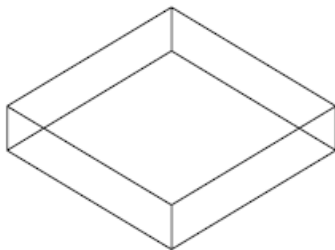

INNER CARTON: 340(L)x340(W)x100(H)

EXPORT CARTON: 360(L)x360(W)x250(H)

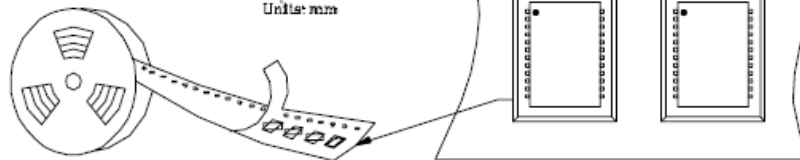
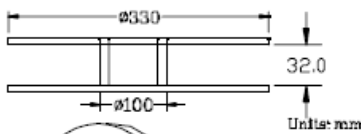

- 1. ONE ROLL: 1500PCS
- 2. TWO ROLL BOX: 3000PCS
- 3. TWO BOX CARTON: 6000PCS

Tel: +86-816-2562292/2561202  
E-mail: [myjwd@myjwd.com](mailto:myjwd@myjwd.com)

Fax: +86-816-2562916  
Website: [www.myjwd.com](http://www.myjwd.com)